

45823

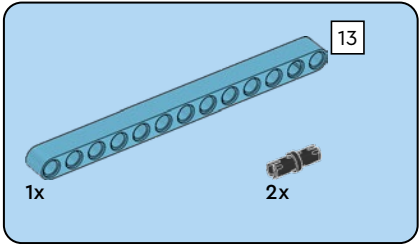

1

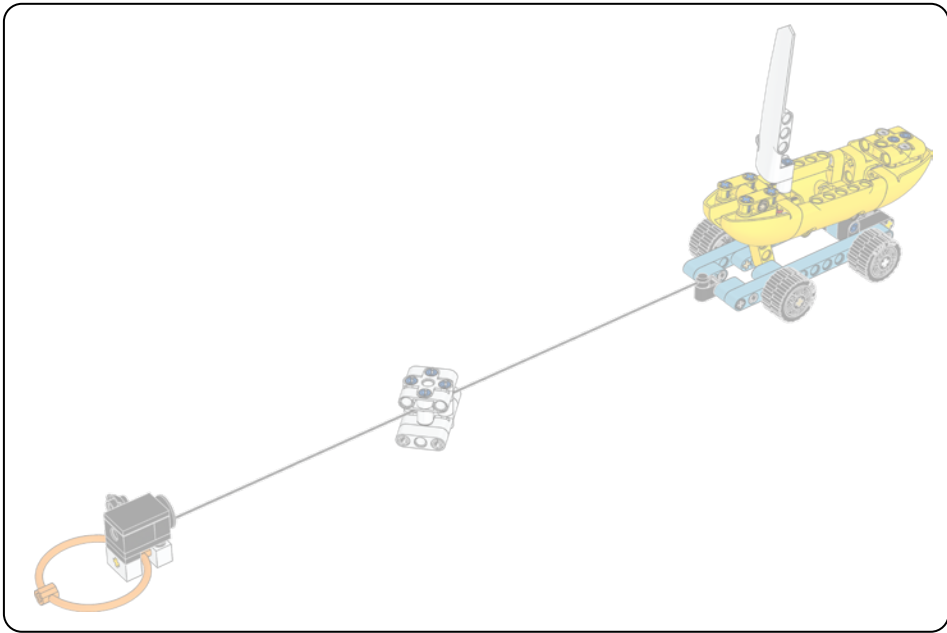
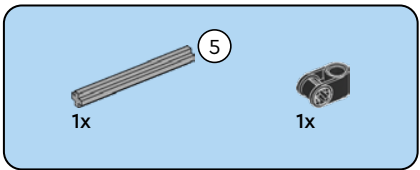
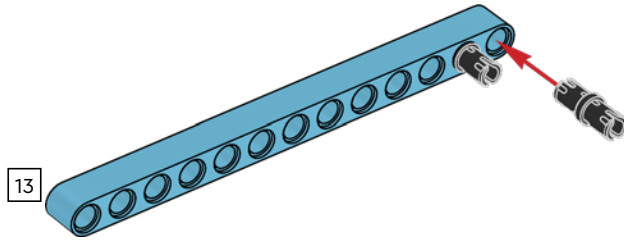

2

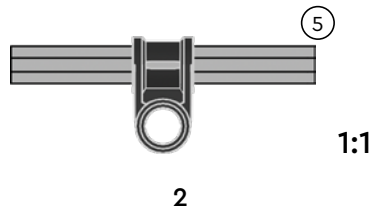

2

1x

3

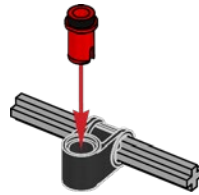

2x

2x

4

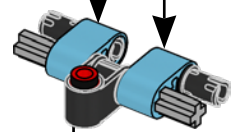
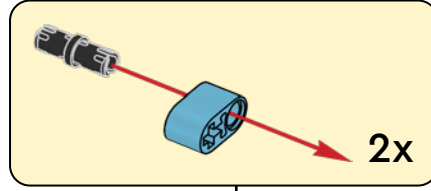

5

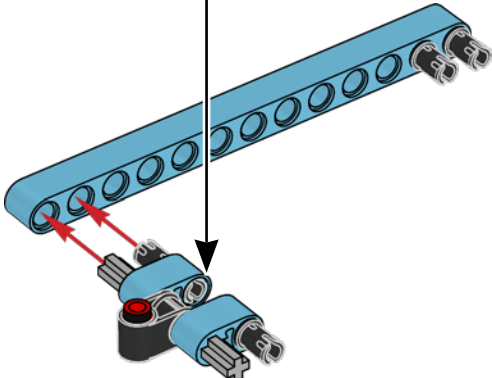

3



6

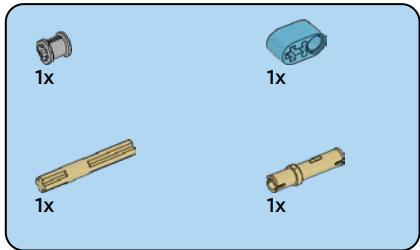
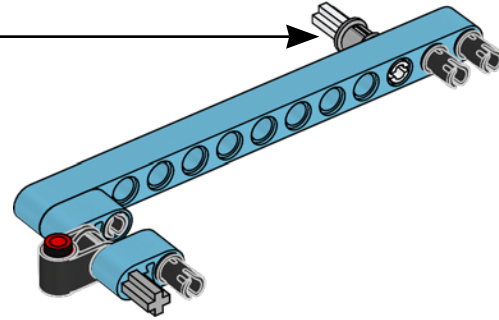
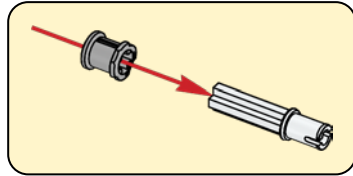

7

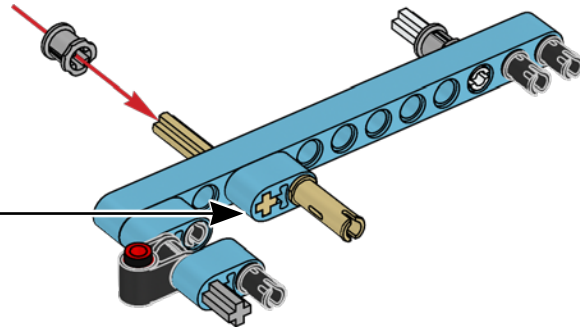
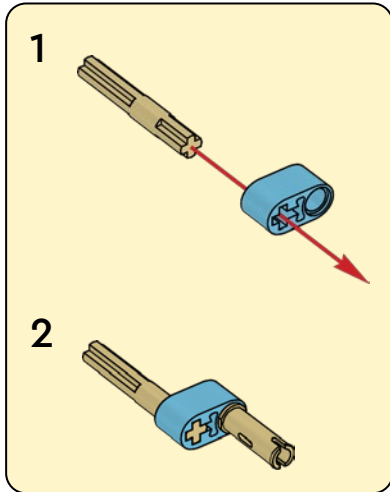

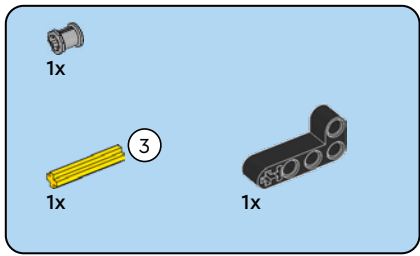

8

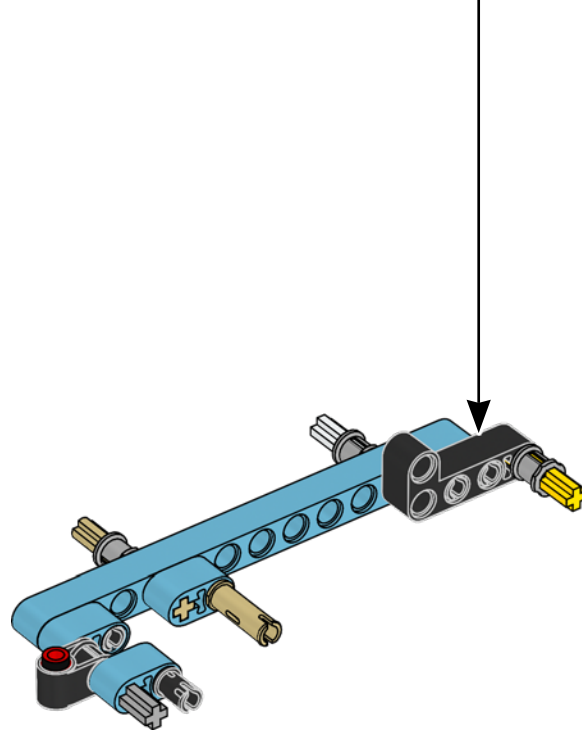
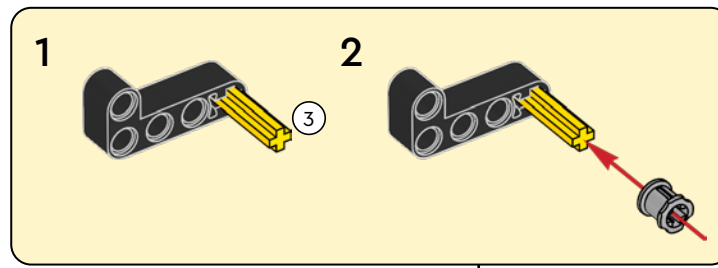

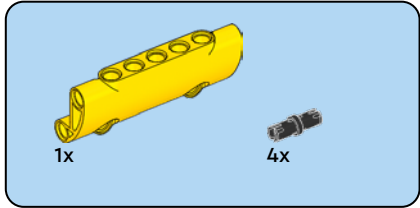
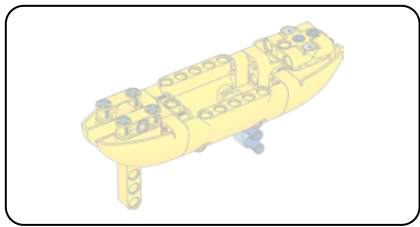

9

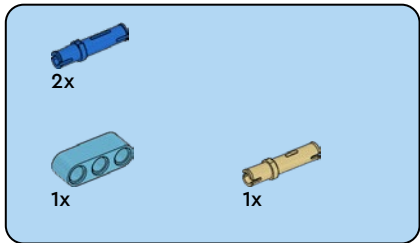
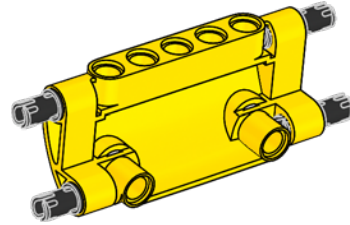

10

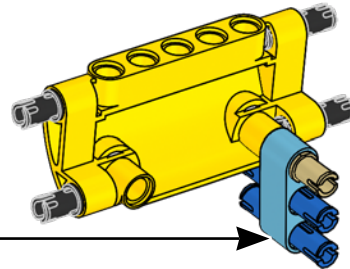
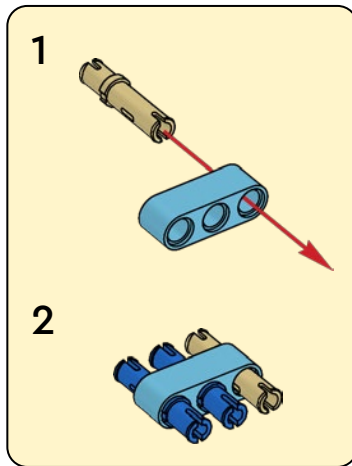

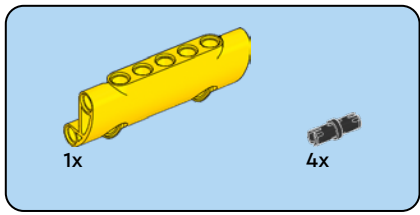

11

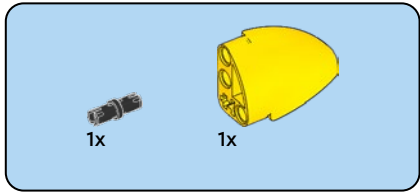
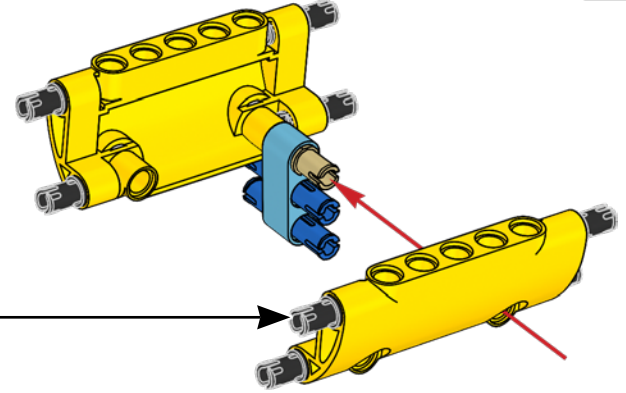
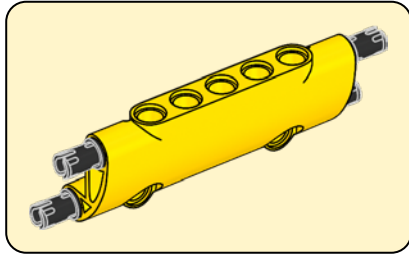

12

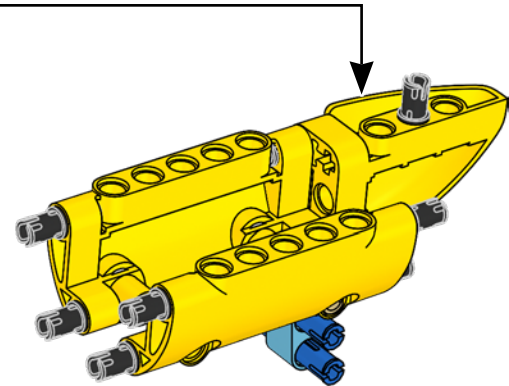
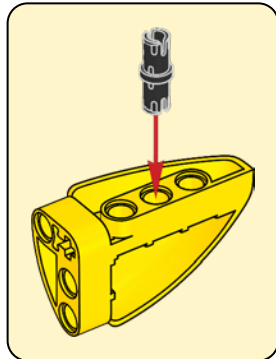

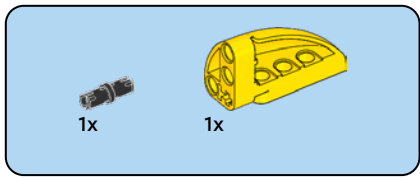

13

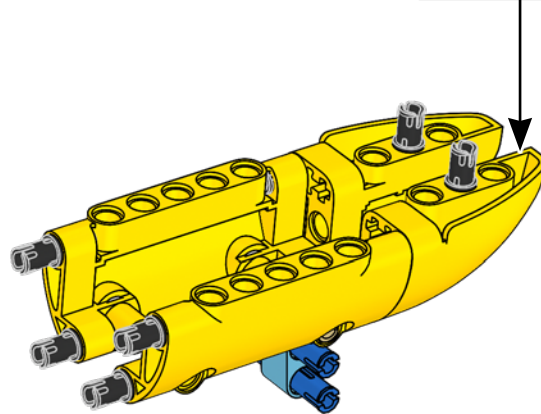
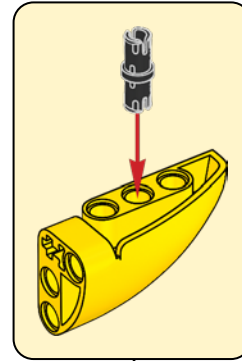



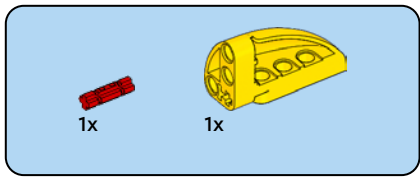

14

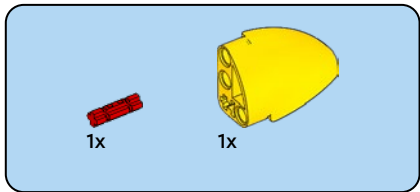
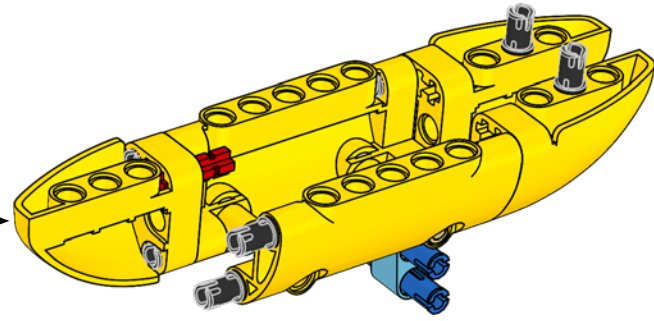
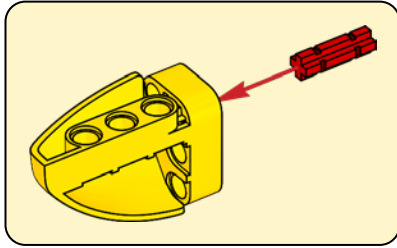

15

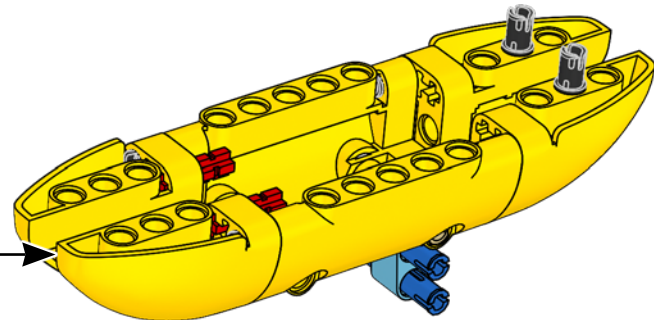
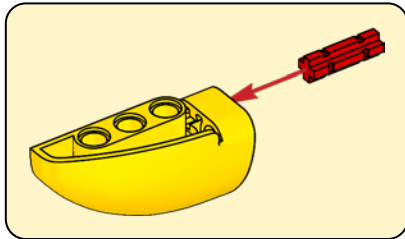

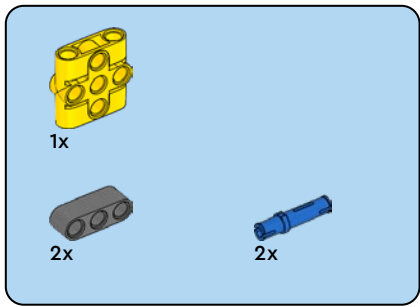

16

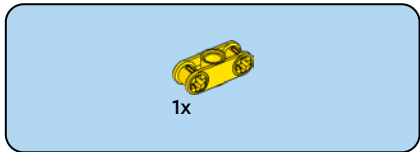
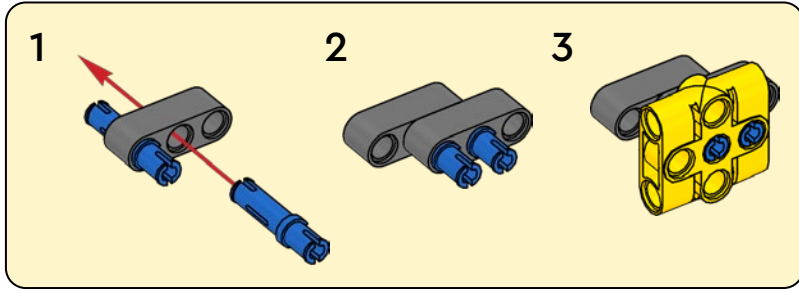

17

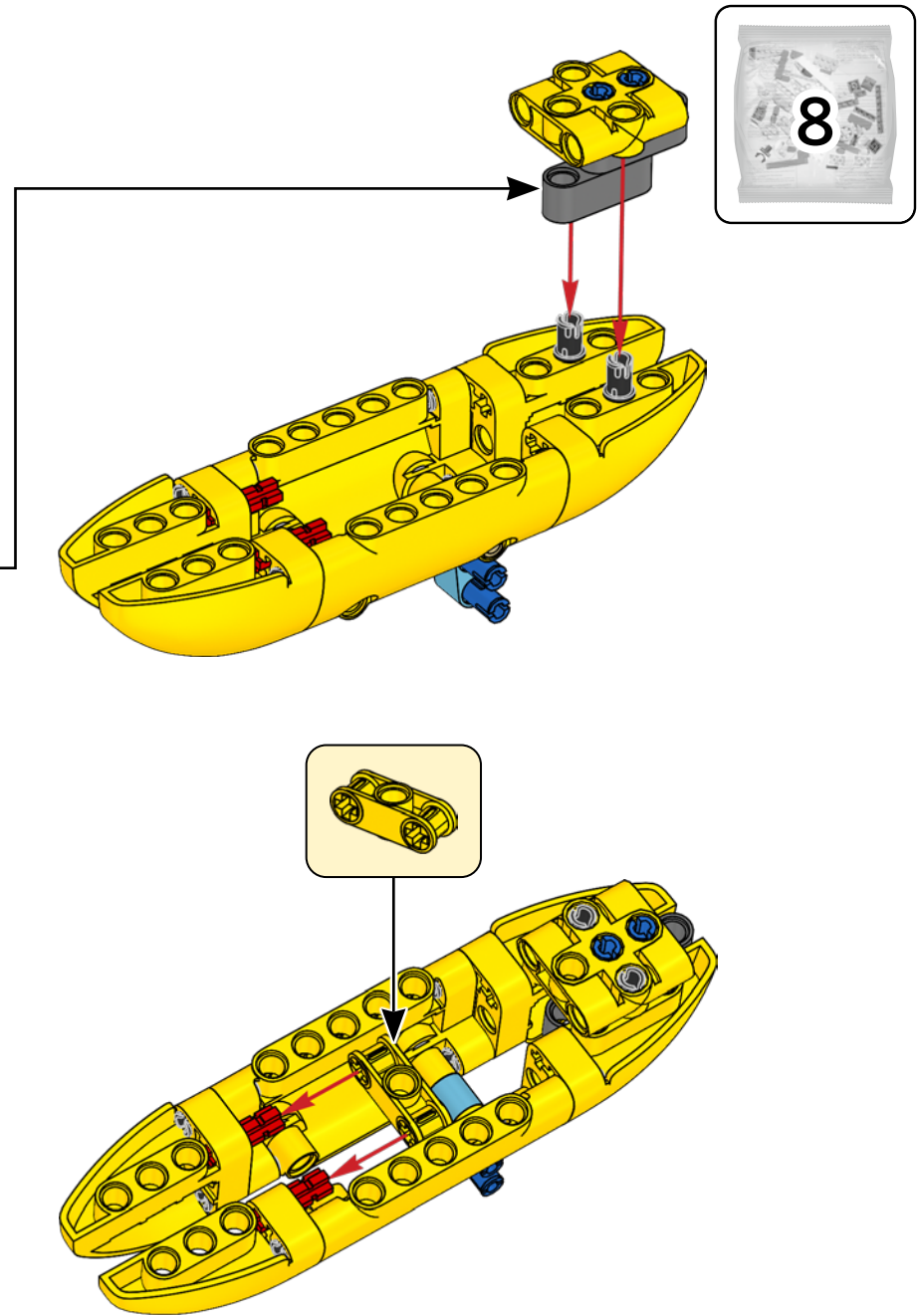

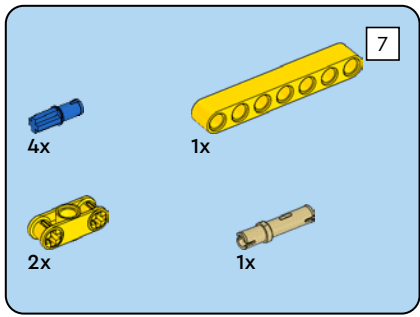

18

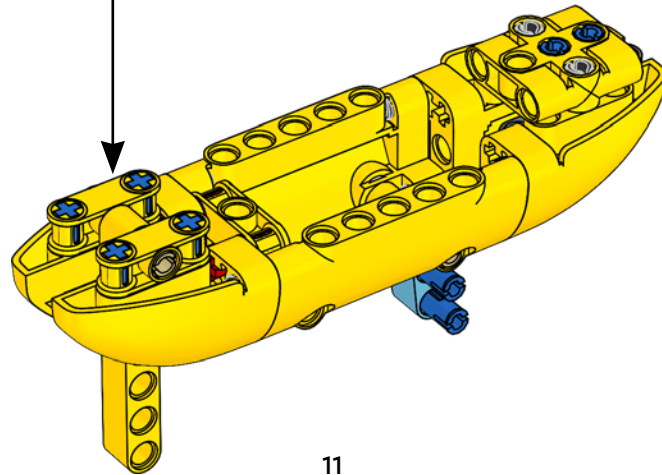
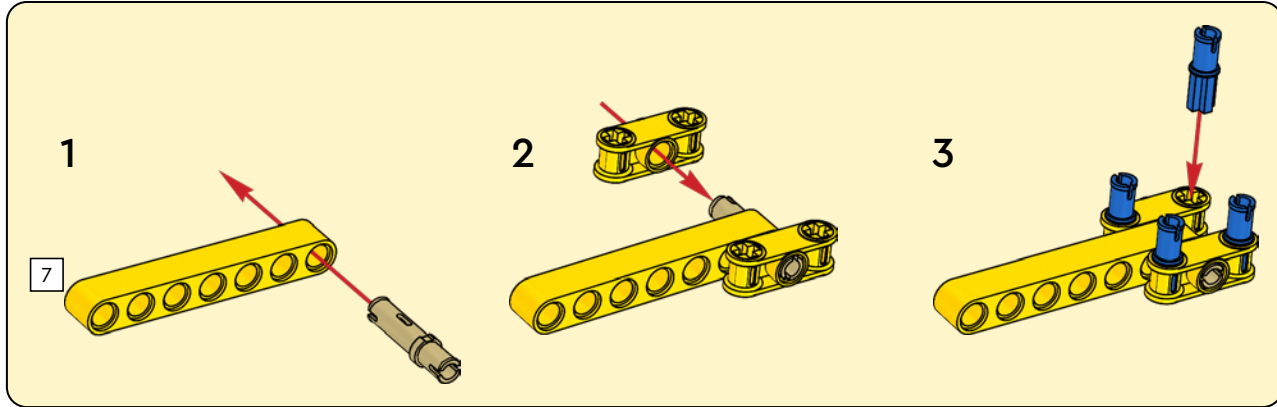

19

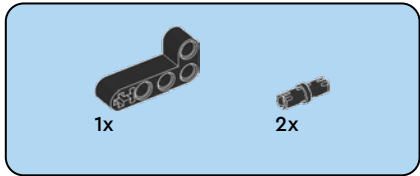
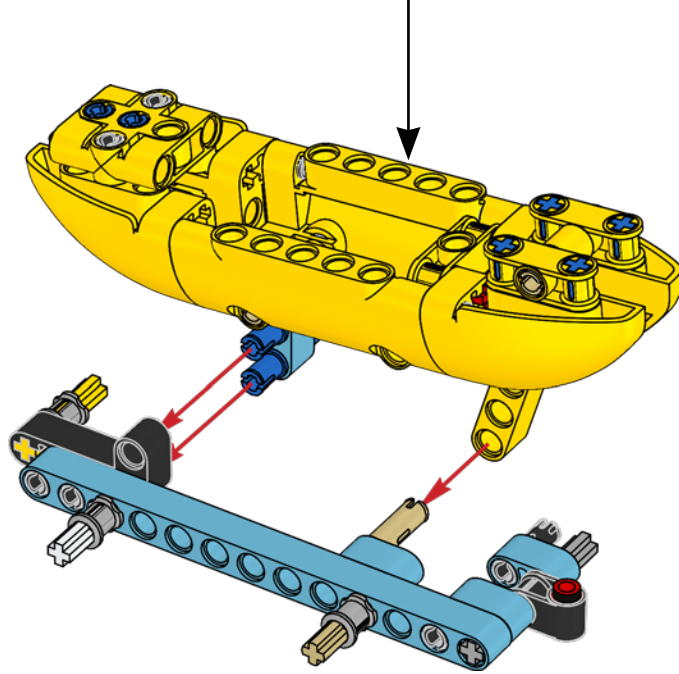

20

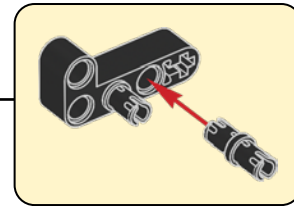
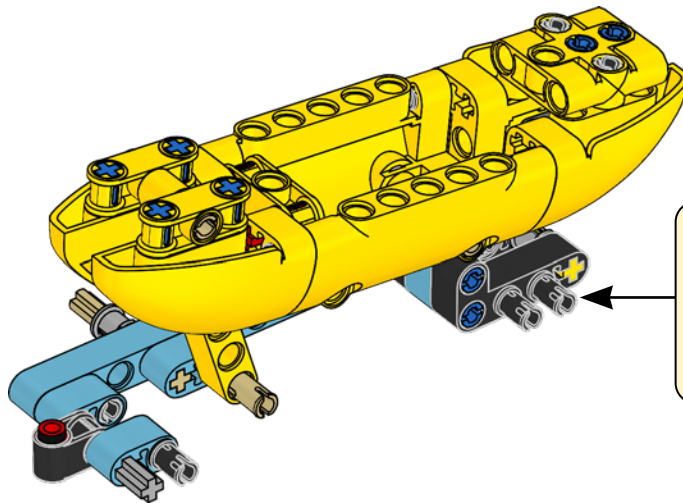
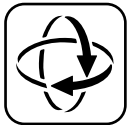

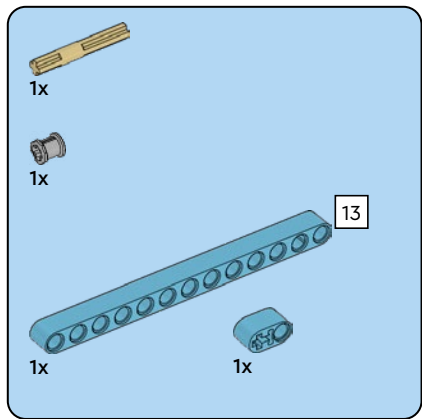

21

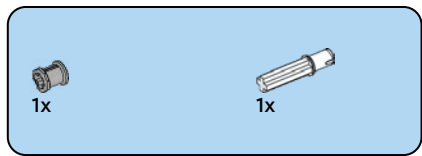
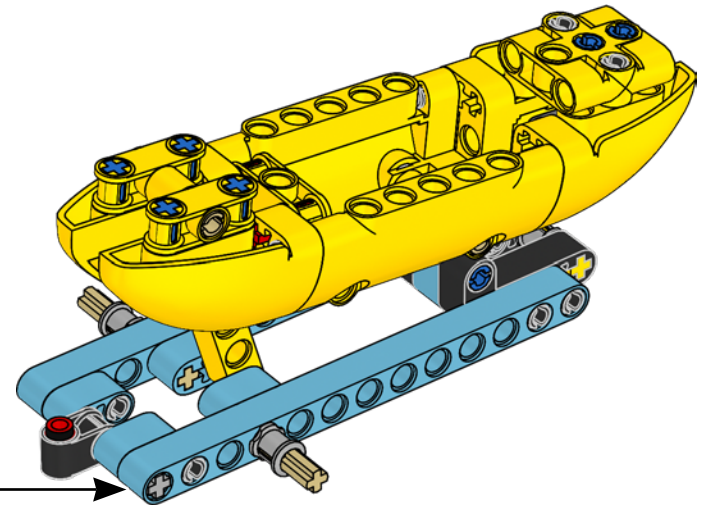
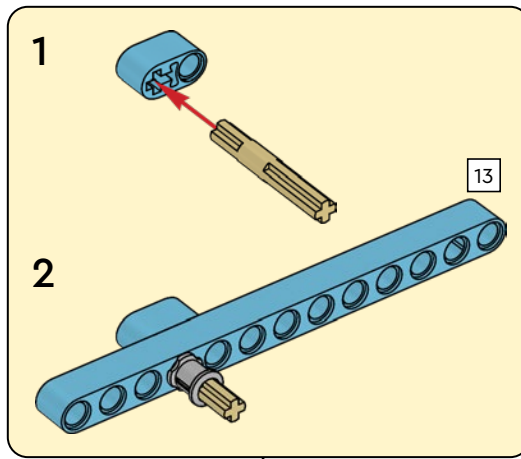

22

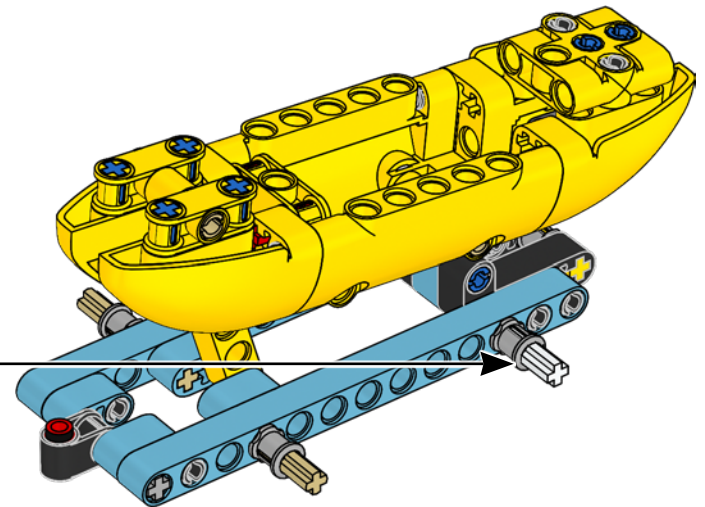
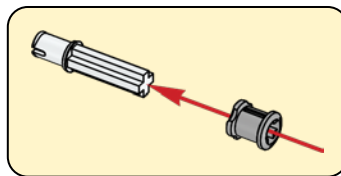

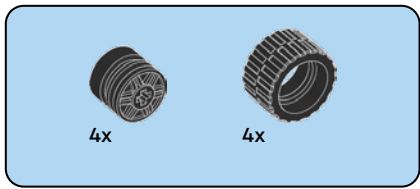

23

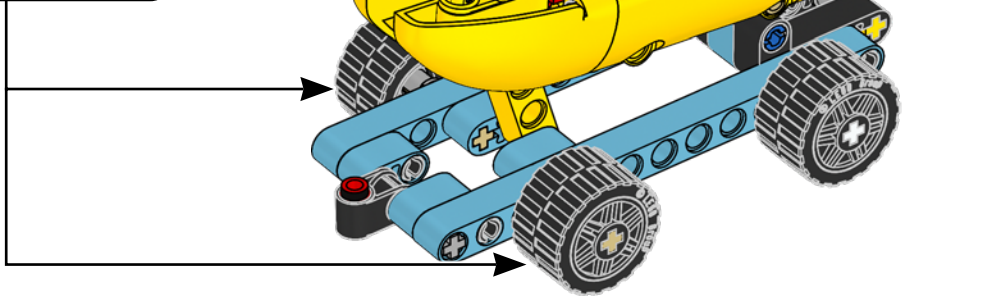
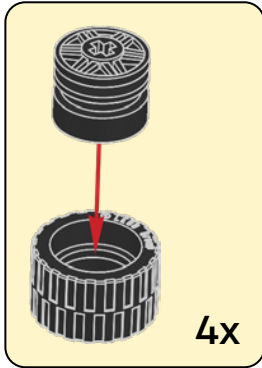

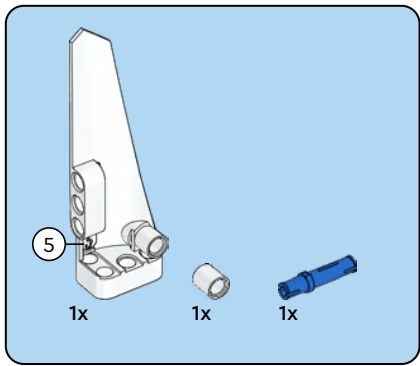

24

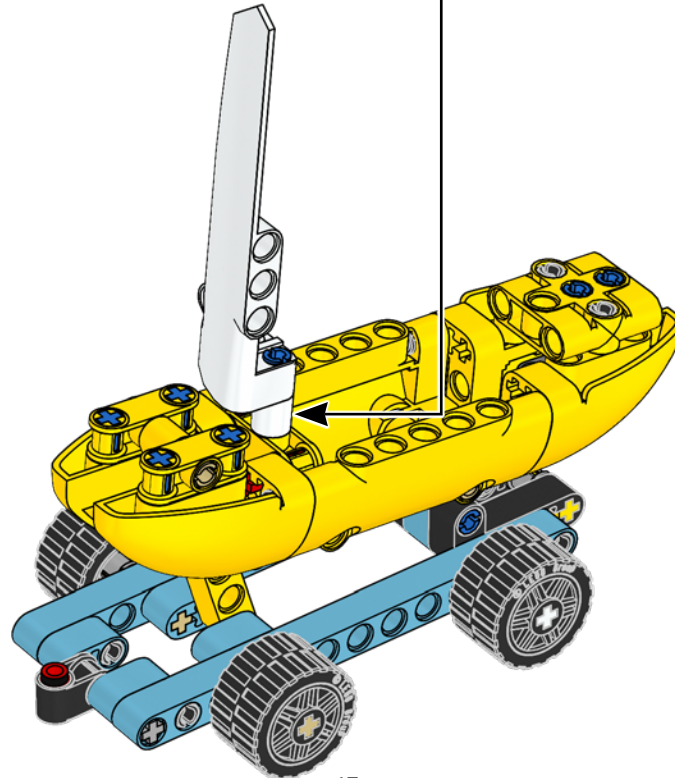
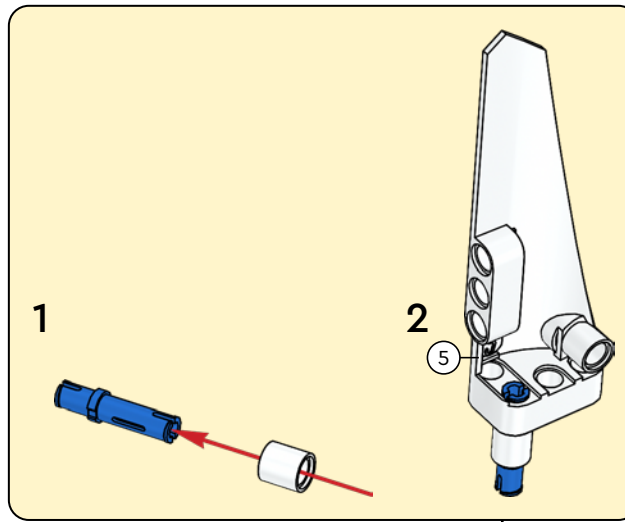



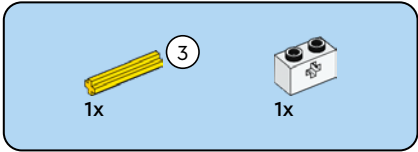
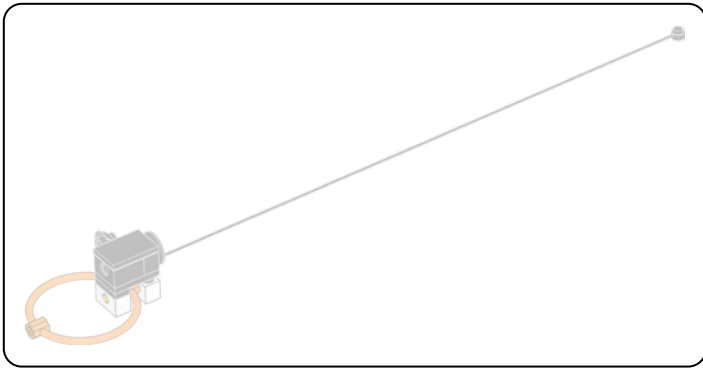

25

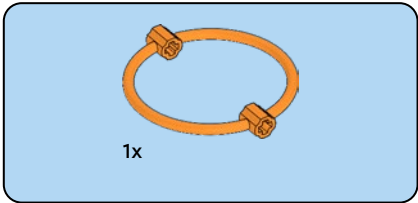
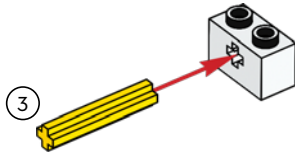

26

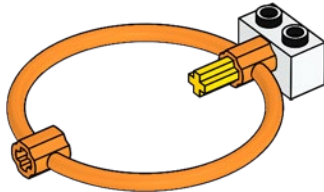





1x

27

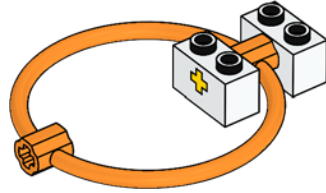

1x

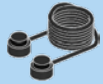

1x



1x

28

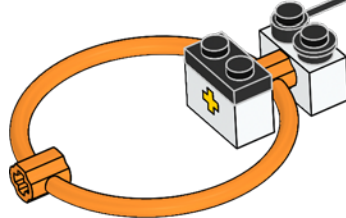

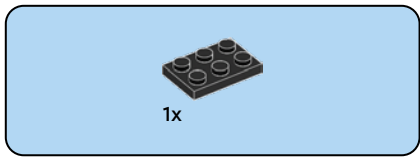

29

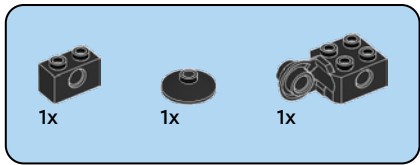
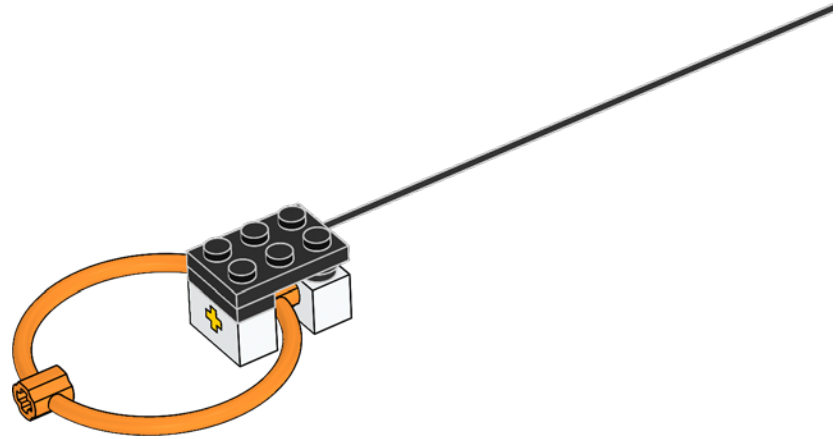

30

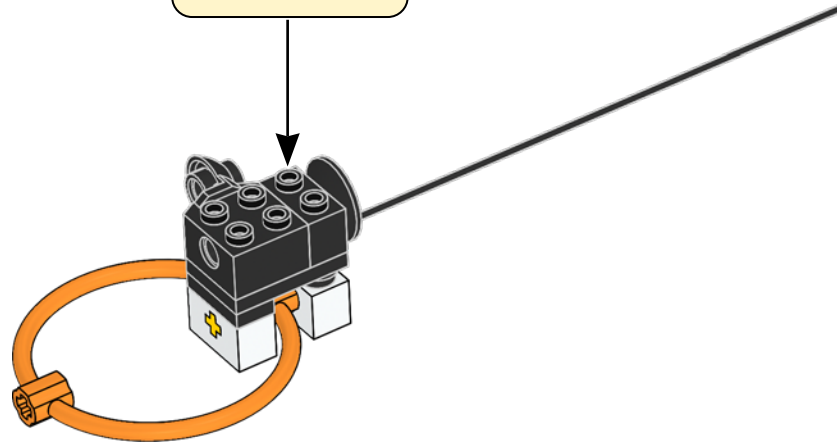
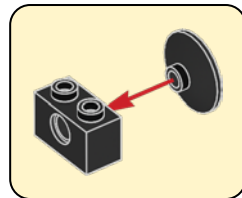

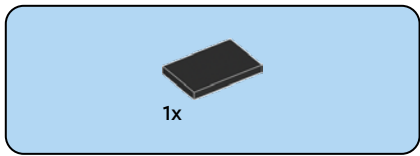

31

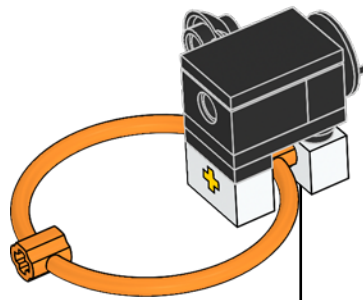

32

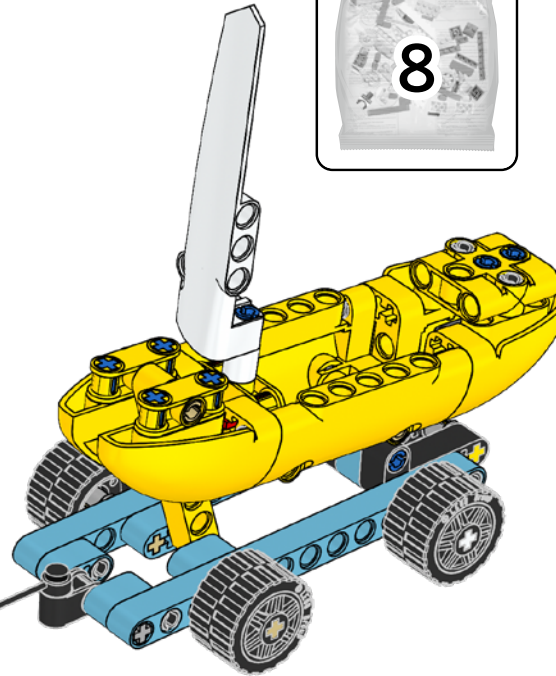
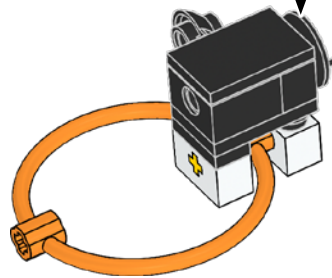

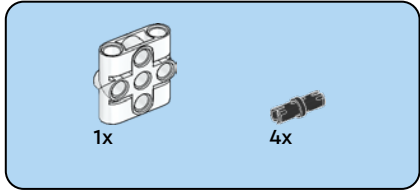
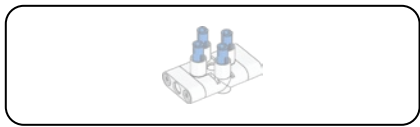

33

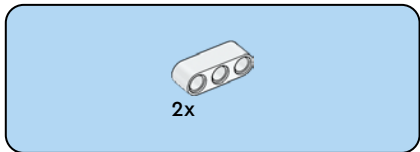
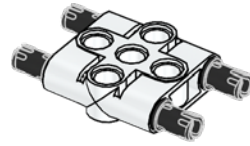

34

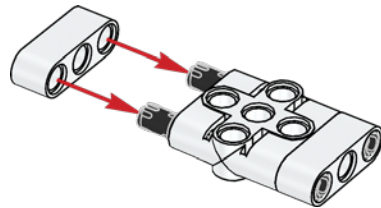

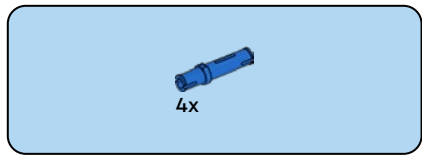

35

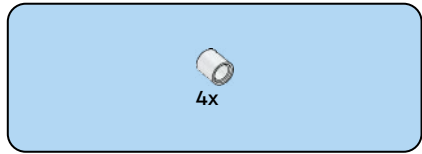
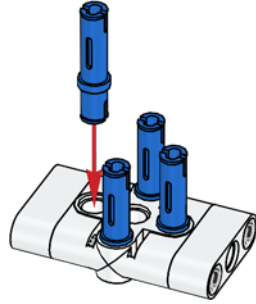

36

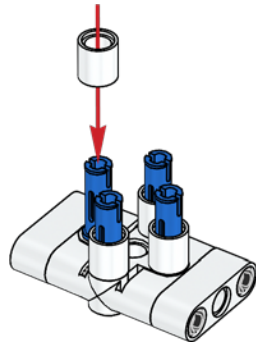

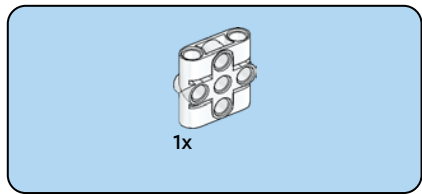

37

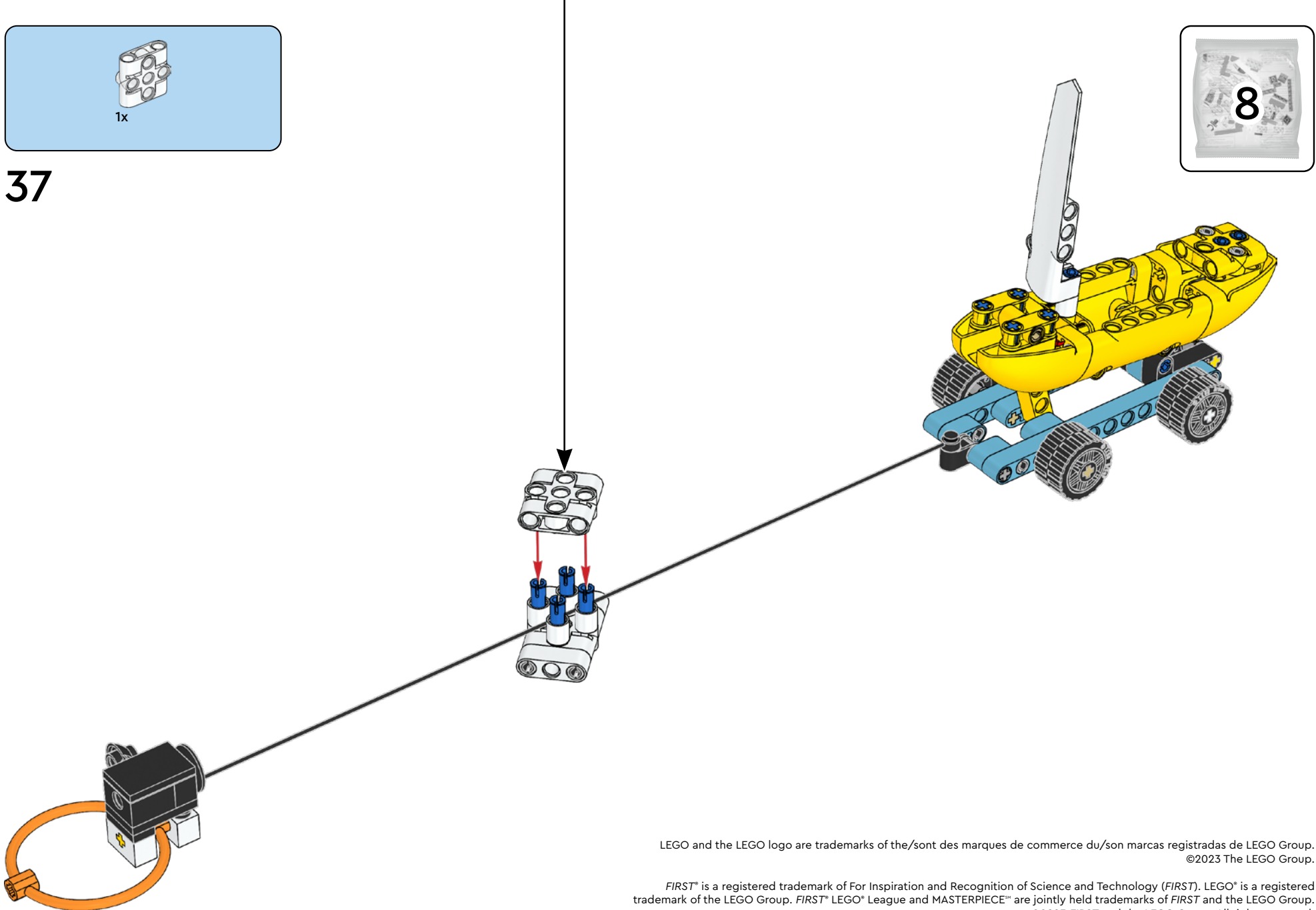

LEGO and the LEGO logo are trademarks of the/sont des marques de commerce du/son marcas registradas de LEGO Group.  
©2023 The LEGO Group.

FIRST® is a registered trademark of For Inspiration and Recognition of Science and Technology (FIRST). LEGO® is a registered trademark of the LEGO Group. FIRST® LEGO® League and MASTERPIECE™ are jointly held trademarks of FIRST and the LEGO Group.  
©2023 FIRST and the LEGO Group. All rights reserved.